

MERRYFAIR®



**TURINI**

Seating Products

## Extraordinary Public Seating

Turini offers a difference from the cold angular lines and technical nature of usual public seatings. Turini's beauty does not only come from the surface, its simple elegant design combines form and function. The deep scoop shape characterises Turini's unique design, while providing a comfortable fit to our body shape. A polished aluminium rim around its elliptical opening lends a premium detail, while providing robust strength for heavy public use.







**Available in****2 Base Options**

- A beam base for linked seating is most suited for high density and high-traffic waiting areas.
- A Trumpet base with auto-return column makes a design statement in more private, 1st class lounges.

**2 Type of Seating Surface**

- Upholstered padding in Fabric, Leather, or Vinyl. Colour polymer shell in various colours for resistance to soiling and staining.
- Seat and back shells are separated, to allow mix and match of different seat, back material and colours.



## Lounge Swivel Seating



Plastic Back  
Plastic Seat  
651NAA00AL



Upholstered Back  
Upholstered Seat  
652NAA00AL



Plastic Back  
Upholstered Seat  
653NAA00AL

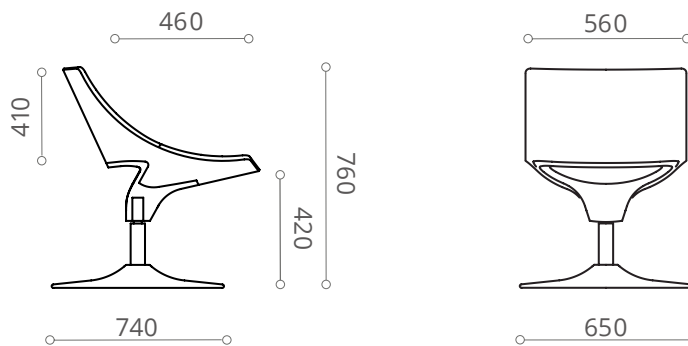

## Beam-linked Seating



Plastic Back  
Plastic Seat  
651B\_A00J

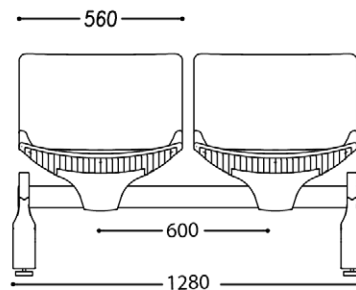

2-Seater  
65\_B2A00J

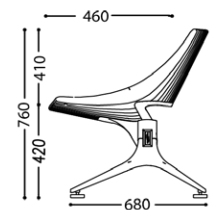



Upholstered Back  
Upholstered Seat  
652B\_A00J

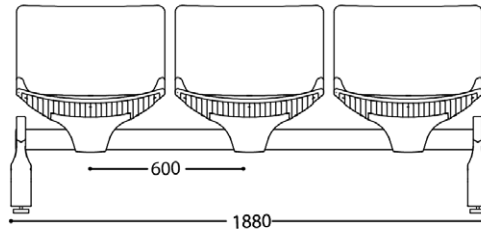

3-Seater  
65\_B3A00J



Plastic Back  
Upholstered Seat  
653B\_A00J

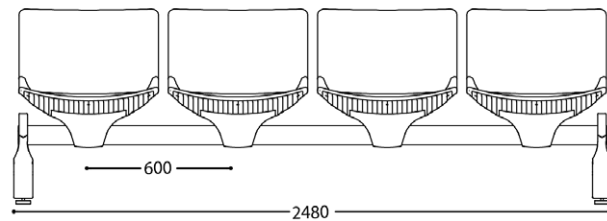

4-Seater  
65\_B4A00J

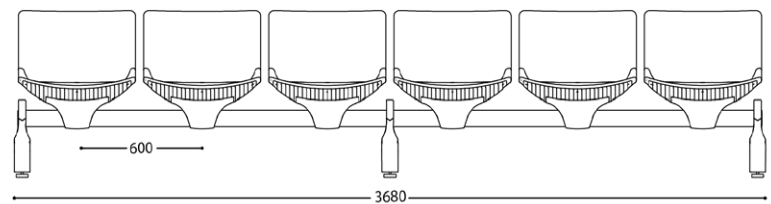
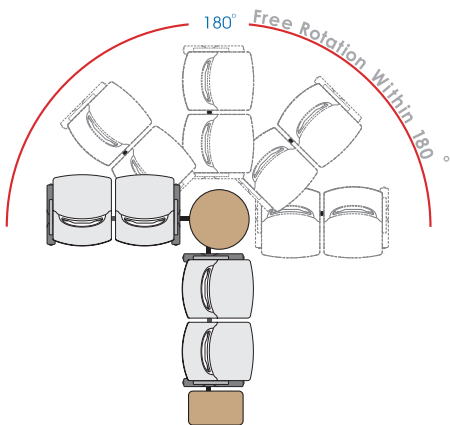

6-Seater  
65\_B6A00J

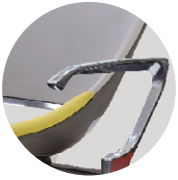
**Turini: Options****Beam Accessories**

Polished Aluminium  
Armrest  
(A28)

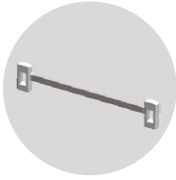

Back-to-back Link  
(L9)

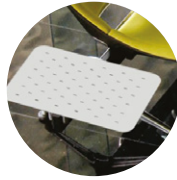

Steel Side Table  
W330 X L475  
(TS4)

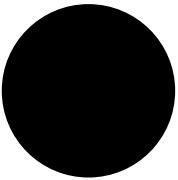

Steel Round table Dia.560  
with articulating beam  
(TT2)

**Plastic Shell Color Options**

Black  
(B)

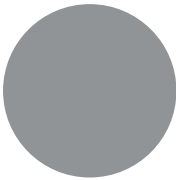

Grey  
(G)

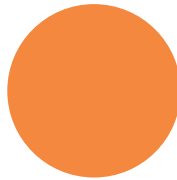

Mango  
(M)



## HEAD OFFICE & FACTORY

[www.merryfair.com](http://www.merryfair.com)

### Merryfair Chair System Sdn Bhd

(Co. No. 86276-A)  
No.2, Jalan Koporat 1/KU9,  
Taman Perindustrian Meru,  
42200 Klang, Selangor D.E., Malaysia.

### International Sales & Marketing

Tel. +603 3393 2888  
Fax. +603 3393 2000  
[enquiry@merryfair.com](mailto:enquiry@merryfair.com)

### Domestic Sales & Marketing

Tel. +603 3393 6868  
Fax. +603 3393 6888  
[domestic@merryfair.com](mailto:domestic@merryfair.com)

## SHOWROOM OFFICE

### Merryfair Marketing Sdn Bhd

(Co. No. 665054-V)  
No. 82-84, Jalan 2/23A,  
Jalan Genting Kelang,  
53300 Kuala Lumpur, Malaysia.  
Tel. +603 4149 8899  
Fax. +603 4143 0113

## REGIONAL OFFICE & SHOWROOM

### 美力菲 (中国) 家具有限公司

广东省佛山市顺德区容桂华口顺德高新区(容桂)华天路21号  
邮编: 528306  
Merryfair (China) Co.,Ltd  
No. 21, Huatian Road, Shunde High Tech Industrial Zone  
(Ronggui), Huakou Community, Ronggui Subdistrict,  
Shunde District, Foshan City, Guangdong, China 528306.  
Tel. +86 757 2636 9861  
Fax. +86 757 2881 9700  
[domestic@merryfair.com.cn](mailto:domestic@merryfair.com.cn)

### Merryfair (Singapore) Pte Ltd

33 Ubi Avenue 3, #01-52/53 Vertex,  
Singapore 408868.  
Tel. +65 6284 9098  
Fax. +65 6284 9028  
[enquiry@merryfair.com.sg](mailto:enquiry@merryfair.com.sg)

### Merryfair (Thailand) Co.,Ltd.

19/1-2 Sithakarn, Soi Chidlom  
Lumpini, Pathumwan  
Bangkok 10330 Thailand  
Tel : +66 2254 1588  
Fax : +66 2254 1585  
[sales@merryfair.co.th](mailto:sales@merryfair.co.th)

MERRYFAIR reserves the right to introduce modifications and withdraw models for continuous improvements without prior notice.

