

MERRYFAIR®



BRAVO

Seating Products

Executive Leather Chair

Bravo leather chair features super soft upholstery and synchronised motion tilt. The chair blends classic luxury with aesthetic designs of the new millennium.



Models: 35_**Headrest**

Cushion Headrest, upholstery in leather or synthetic leather in various colour, adjustable for 5cm in height.

Backrest

Upholstery choice is offered in leather or synthetic leather in various colour.

Armrest

Fixed armrests. Upholstery choice is offered in leather or synthetic leather in various colour.

Also available in a 3-way Armrest with additional adjustments for 6cm in height, which armpad can adjust for 6cm in depth, and swivel into 3-angular positions.

Mechanism

Synchronized mechanism with Tilt Tension Control, multi position Tilt Lock, and pneumatic seat height control.

Base

Standard base in moulded polypropylene (PP) in black colour.

**Models: 34_****Headrest**

Cushion Headrest, upholstery in fabric in various colour, adjustable for 5cm in height.

Backrest

Upholstery choice is offered in fabric in various colour.

Armrest

Fixed armrests. moulded in Polypropylene(PP) in standard black colour.

Also available in a 3-way Armrest with additional adjustments for 6cm in height, which armpad can adjust for 6cm in depth, and swivel into 3-angular positions.

Mechanism

Synchronized mechanism with Tilt Tension Control, multi position Tilt Lock, and pneumatic seat height control.

Base

Standard base in moulded polypropylene (PP) in black colour.





Bravo series features an elegant innovative combination of plastic and fabric. Together with its ergonomics features and mechanisms, it brings responsive comfort encouraging productivity.

Their classic appearance and confident character give these chairs continuing appeal as executive and management chairs, and for conference and other applications.

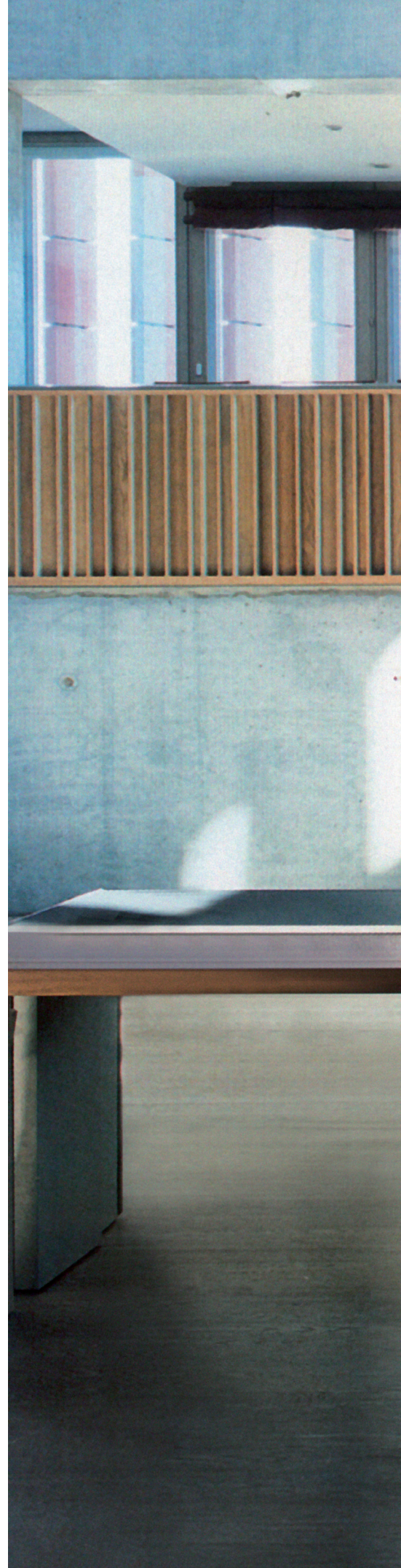



Model: 35_

High-back
359 YC A38 N2

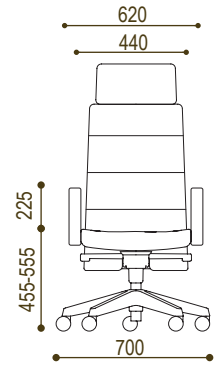
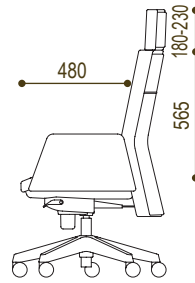

Mid-back

358 YC A38 N2

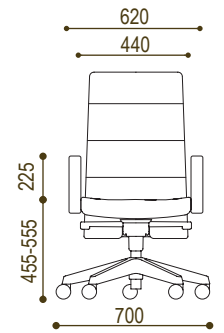
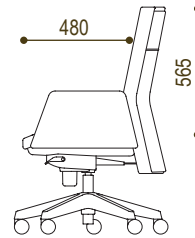

Low-back

357 YC A38 N2

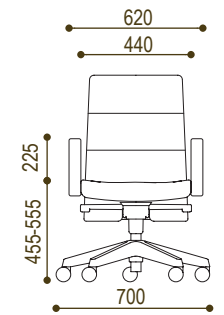
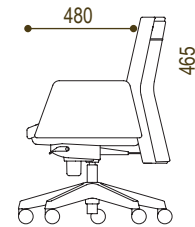

Visitor

351 NA A38 B

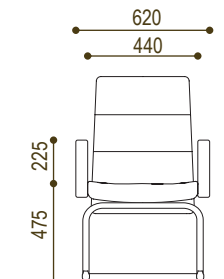
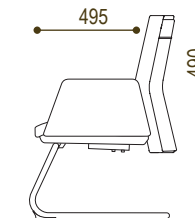

Height Adjustable Headrest



Synchronized Mechanism



Pneumatic Seat
Height Adjustment

Option Armrest



Upholstered
Armrests
(A38)



Adjustable
Armrests
(A4S)

Mechanism



Synchronized
Mechanism
(YC)

Base



350 Studio Base
(N2)



Cantilever Base
(B)

Features



Height adjustable armrests with swivel and depth adjustable armpad.



Fixed armrests. Upholstery choice is offered in leather or synthetic leather in various colour.



Synchronized mechanism with Tilt Tension Control, multi position Tilt Lock, and pneumatic seat height control.



Quick and easy pull-up height adjustable headrest to suit individual preferences.

Model: 34_

High-back
349 YC A4S N2

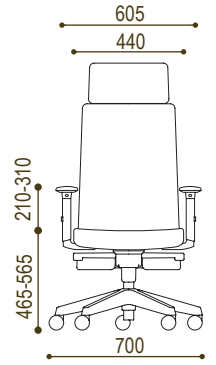
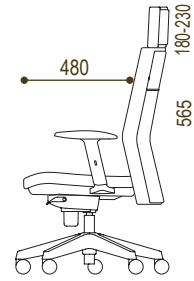
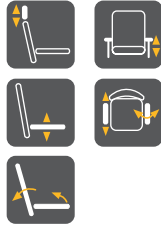

Mid-back

348 YC A4S N2

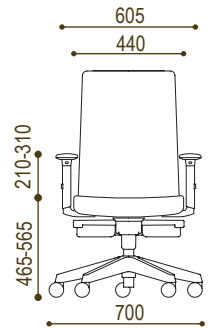
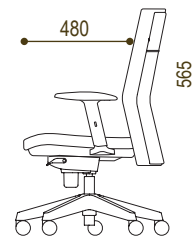

Low-back

347 YC A4S N2

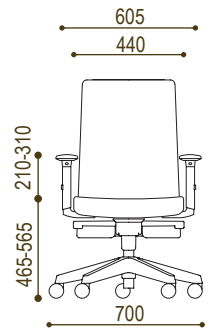

Visitor

341 NA A37 B

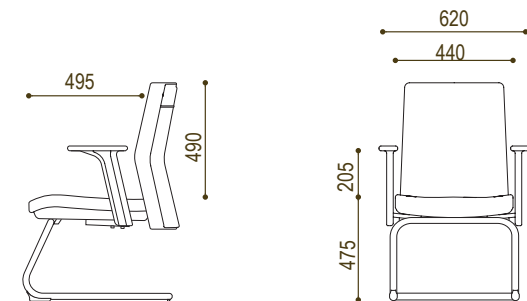

Height Adjustable Headrest



Synchronized Mechanism



Pneumatic Seat
Height Adjustment



Height Adjustable Armrest



Depth-Angle Adjustable Armpad
2-way adjustable armpad

Option Armrest



Adjustable
Armrests
(A4S)



Fixed
Armrests
(A37)

Mechanism



Synchronized
Mechanism
(YC)

Base



350 Studio Base
(N2)



Cantilever Base
(B)

Features



Synchronized mechanism with multiple locking positions enables seating comfort. (YC)



Quick and easy pull-up height adjustable headrest to suit individual preferences.



Height adjustable armrests with swivel and depth adjustable armrest. (A4S)



These styling armrests made of highly durable material to provide firm arm support and comfort. (A37)

HEAD OFFICE & FACTORY

www.merryfair.com

Merryfair Chair System Sdn Bhd

(Co. No. 86276-A)
No.2, Jalan Koporat 1/KU9,
Taman Perindustrian Meru,
42200 Klang, Selangor D.E., Malaysia.

International Sales & Marketing

Tel. +603 3393 2888
Fax. +603 3393 2000
enquiry@merryfair.com

Domestic Sales & Marketing

Tel. +603 3393 6868
Fax. +603 3393 6888
domestic@merryfair.com

SHOWROOM OFFICE

Merryfair Marketing Sdn Bhd

(Co. No. 665054-V)
No. 82-84, Jalan 2/23A,
Jalan Genting Kelang,
53300 Kuala Lumpur, Malaysia.
Tel. +603 4149 8899
Fax. +603 4143 0113

REGIONAL OFFICE & SHOWROOM

美力菲 (中国) 家具有限公司

广东省佛山市顺德区容桂华口顺德高新区(容桂)华天路21号
邮编: 528306
Merryfair (China) Co.,Ltd
No. 21, Huatian Road, Shunde High Tech Industrial Zone
(Ronggui), Huakou Community, Ronggui Subdistrict,
Shunde District, Foshan City, Guangdong, China 528306.
Tel. +86 757 2636 9861
Fax. +86 757 2881 9700
domestic@merryfair.com.cn

Merryfair (Singapore) Pte Ltd

33 Ubi Avenue 3, #01-52/53 Vertex,
Singapore 408868.
Tel. +65 6284 9098
Fax. +65 6284 9028
enquiry@merryfair.com.sg

Merryfair (Thailand) Co.,Ltd.

19/1-2 Sithakarn, Soi Chidlom
Lumpini, Pathumwan
Bangkok 10330 Thailand
Tel : +66 2254 1588
Fax : +66 2254 1585
sales@merryfair.co.th

