

Assembly Instruction

MERRYFAIR®

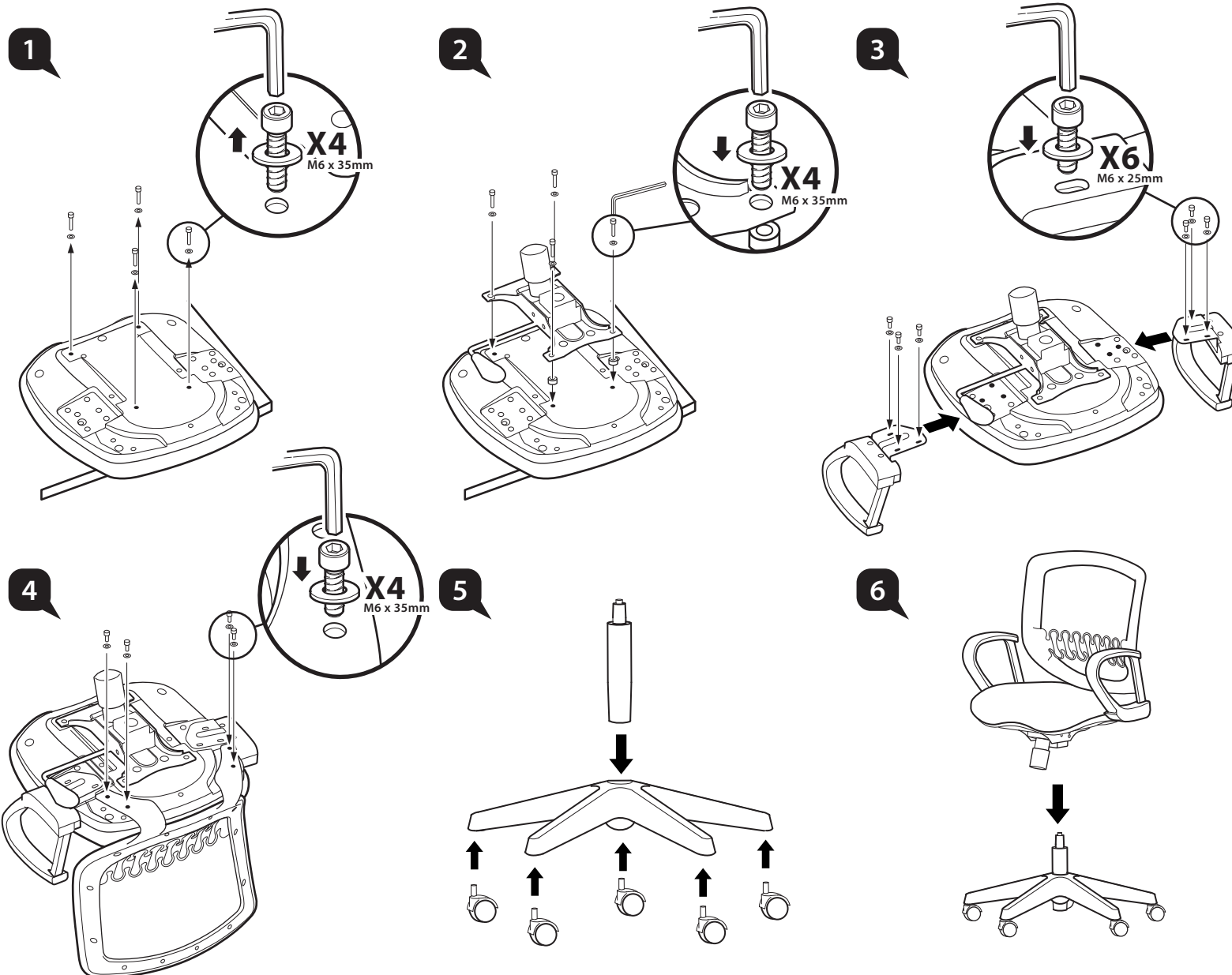

Esie
model: 367 SH A15 N3

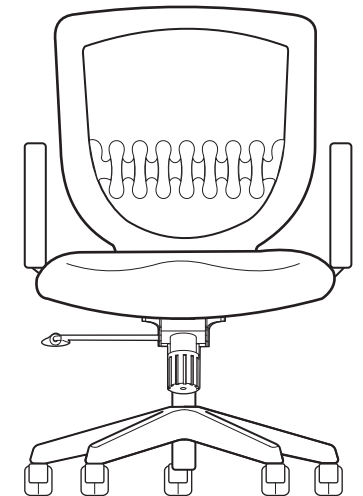

User Instructions

MERRYFAIR®

A *Seat Height Adjustable*

Flip up lever on right-side to raise or lower seat. Adjust such that your feet are adequately supported on floor.

B *Tilt Lock*

Only have 2 locking positions for this series. At up right position or recline to maximum and push in lever to lock. Pull out lever to release tilt-lock.

C *Tilt Tension Control*

Turn bottom knob clockwise to provide a stronger tilt tension, and vice-versa. Adjust such that minimum effort is required to push back when recline.

Esie

model: 367 SH A15 N3

