

TURINI

MERRYFAIR®

Seating Products



Extraordinary Public Seating

Turini offers a difference from the cold angular lines and technical nature of usual public seatings. Turini's beauty does not only come from the surface, its simple elegant design combines form and function. The deep scoop shape characterises Turini's unique design, while providing a comfortable fit to our body shape. A polished aluminium rim around its elliptical opening lends a premium detail, while providing robust strength for heavy public use.



Available in**2 Base Options**

- A beam base for linked seating is most suited for high density and high-traffic waiting areas.
- A Trumpet base with auto-return column makes a design statement in more private, 1st class lounges.

2 Type of Seating Surface

- Upholstered padding in Fabric, Leather, or Vinyl. Colour polymer shell in various colours for resistance to soiling and staining.
- Seat and back shells are separated, to allow mix and match of different seat, back material and colours.



Lounge Swivel Seating



Plastic Back
Plastic Seat
651NAA00AL



Upholstered Back
Upholstered Seat
652NAA00AL



Plastic Back
Upholstered Seat
653NAA00AL

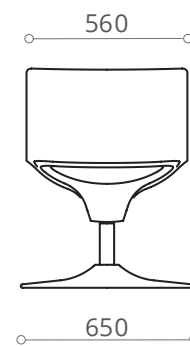
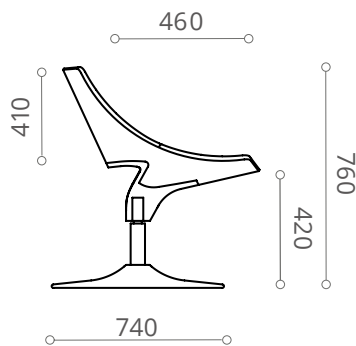

Beam-linked Seating



Plastic Back
Plastic Seat
651B_A00J

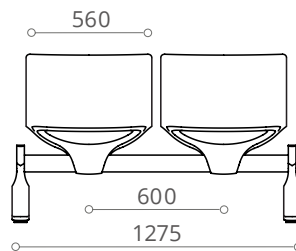

2-Seater
65_B2A00J

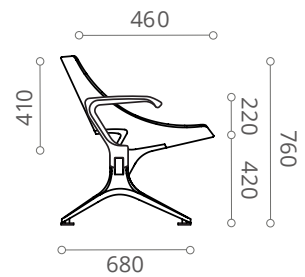



Upholstered Back
Upholstered Seat
652B_A00J

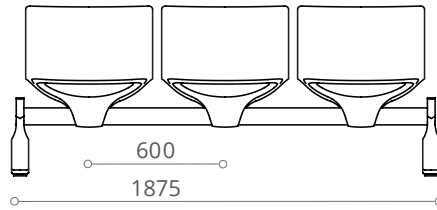

3-Seater
65_B3A00J



Plastic Back
Upholstered Seat
653B_A00J

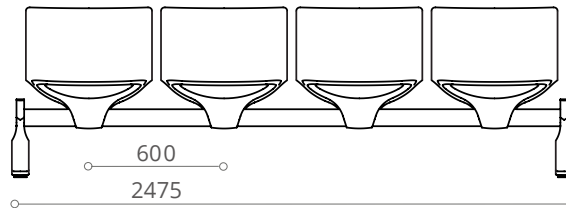

4-Seater
65_B4A00J

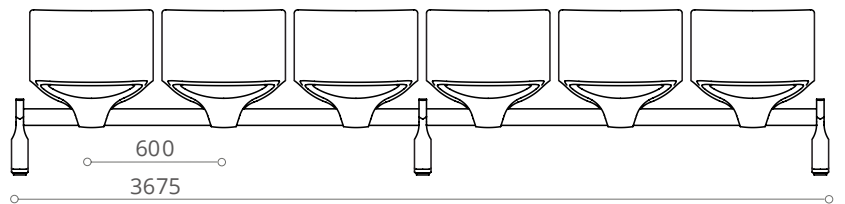
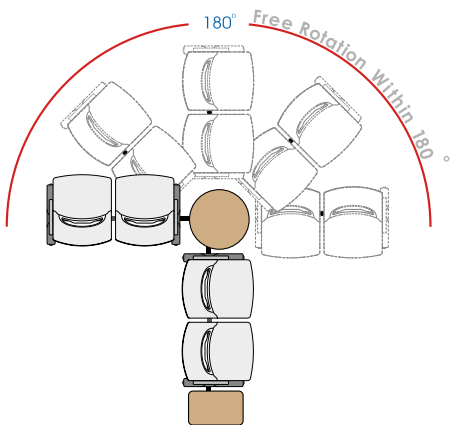

6-Seater
65_B6A00J

Turini: Options

Beam Accessories



Polished Aluminium
Armrest
(A28)



Back-to-back Link
(L9)



Steel Side Table
W330 X L475
(TS4)



Steel Round table Dia.560
with articulating beam
(TT2)

Plastic Shell Color Options

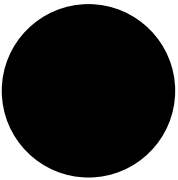

Black
(B)

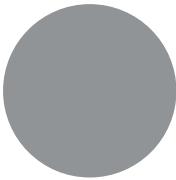

Grey
(G)

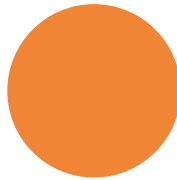

Mango
(M)



HEAD OFFICE & FACTORY

Merryfair Chair System Sdn Bhd
(Co. No. 86276-A)
No.2, Jalan Koporat 1/KU9,
Taman Perindustrian Meru,
42200 Klang, Selangor D.E., Malaysia.

International Sales & Marketing
Tel. +603 3393 2888
Fax. +603 3393 2000
enquiry@merryfair.com

Domestic Sales & Marketing
Tel. +603 3393 6868
Fax. +603 3393 6888
domestic@merryfair.com

SHOWROOM OFFICE

Merryfair Marketing Sdn Bhd
(Co. No. 665054-V)
No. 82-84, Jalan 2/23A,
Jalan Genting Kelang,
53300 Kuala Lumpur, Malaysia.
Tel. +603 4149 8899
Fax. +603 4143 0113

REGIONAL OFFICE & SHOWROOM

美力菲 (中国) 家具有限公司
广东省佛山市顺德区容桂华口顺德高新区(容桂)华天路21号
邮编: 528306
Merryfair (China) Co.,Ltd
No. 21, Huatian Road, Shunde High Tech Industrial Zone
(Ronggui), Huakou Community, Ronggui Subdistrict,
Shunde District, Foshan City, Guangdong, China 528306.
Tel. +86 757 2636 9861
Fax. +86 757 2881 9700
domestic@merryfair.com.cn

Merryfair (Singapore) Pte Ltd
33 Ubi Avenue 3, #01-52/53 Vertex,
Singapore 408868.
Tel. +65 6284 9098
Fax. +65 6284 9028
enquiry@merryfair.com.sg

Merryfair (Thailand) Co.,Ltd
Thai Samut Building
Ground Floor, 163 Surawongse Road,
Bangrak, Bangkok 10500 Thailand.
Tel. +66 2266 3855
Fax. +66 2266 3859
sales@merryfair.co.th

www.merryfair.com

