

# ROVER

MERRYFAIR®

Seating Products



### **The Modern Classroom**

Rover is the tool that will cross boundaries of “immobile” classrooms, enabling educators to provide a modern and effective arena for learning. Rover is designed to be mobile and adaptable in limited spaces and dense classrooms. A room can be transformed from theatre setting to a U-shaped setting effortlessly by moving the chairs around. This allows for maximum utilisation of space as well as increasing interaction between student and teacher.



## Model: 92\_BC AW1 AP



## Features

---



Back shell design breathes like mesh.

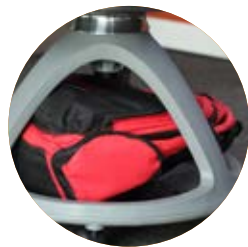

The base tray provides approximate 35 liters space for personal belongings.



Plastic seat shell comes in 3 colour options and require less maintenance.



Foldable A4 size writing tablet with Anti-Panic mechanism is tested to 50kg loads.

Model: 92\_BD AW1 AR



## Features



Back shell design breathes like mesh.



The base tray provides approximate 30 liters space for personal belongings. Pockets on both side for drinks bottles etc.

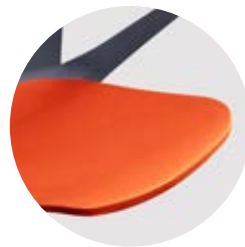

Plastic seat shell comes in 3 colour options and require less maintenance.



A3 size tablet, 360° swingable on its support arm. Slot for tablet or mobile devices.

### Seat Shell

Injection-moulded polypropylene shell in choice of 3 colours (100% recyclable).

### Optional Seat Upholstery

Upholstered over polyurethane cut foam (recyclable into carpet padding, wadding etc).

### Tablet

#### Model: BD

A3 size tablet can swing 360° on its support arm for left or right handed arounded seat. Slot for tablet or mobile devices.

### Base

#### AR Square Base

Moulded polypropylene base in standard grey colour equipped with 50mm dual-wheel castors.

### Chair Shell

Injection-moulded polypropylene shell in white or grey (100% recyclable).

### Tablet

#### Model: BC

Writing tablet uses an anti-panic mechanism and is tested to 50kg loads. Its generous size accommodates an open A4 book or 15" notebook computer. Recessions for a pen and cup.

### Base

#### AP Tri-pod Base

600mm diameter storage base of grey moulded polypropylene equipped with 50mm dual-wheel castors.





PP Seat  
923P BC AW1 AP



Padded Seat  
924P BC AW1 AP

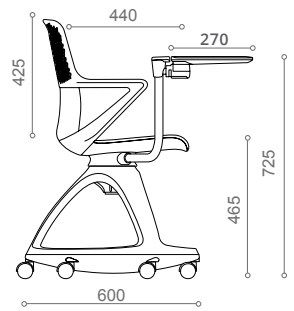
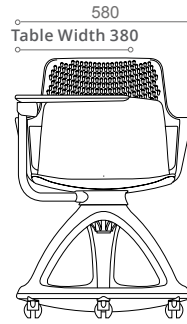

923P BD AW1 AR



924P BD AW1 AR

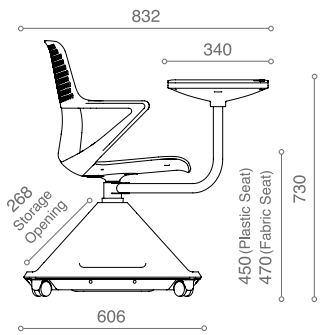
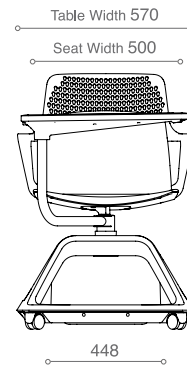

923G HB A71 N3



924G HB A71 N3

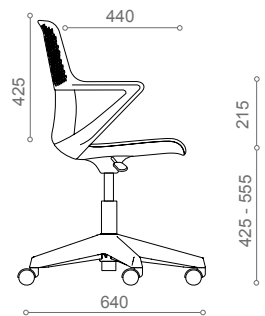
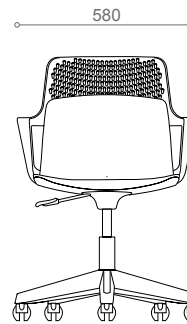

Rover: Option  
PP Seat Colour

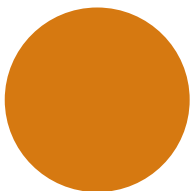

Mango  
(M)

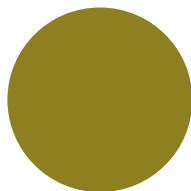

Olive  
(L)

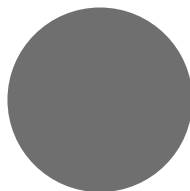

Charcoal  
(C)

## HEAD OFFICE & FACTORY

**Merryfair Chair System Sdn Bhd**  
(Co. No. 86276-A)  
No.2, Jalan Koporat 1/KU9,  
Taman Perindustrian Meru,  
42200 Klang, Selangor D.E., Malaysia.

**International Sales & Marketing**  
Tel. +603 3393 2888  
Fax. +603 3393 2000  
enquiry@merryfair.com

**Domestic Sales & Marketing**  
Tel. +603 3393 6868  
Fax. +603 3393 6888  
domestic@merryfair.com

## SHOWROOM OFFICE

**Merryfair Marketing Sdn Bhd**  
(Co. No. 665054-V)  
No. 82-84, Jalan 2/23A,  
Jalan Genting Kelang,  
53300 Kuala Lumpur, Malaysia.  
Tel. +603 4149 8899  
Fax. +603 4143 0113

## REGIONAL OFFICE & SHOWROOM

**美力菲 (中国) 家具有限公司**  
广东省佛山市顺德区容桂华口顺德高新区(容桂)华天路21号  
邮编: 528306  
Merryfair (China) Co.,Ltd  
No. 21, Huatian Road, Shunde High Tech Industrial Zone  
(Ronggui), Huakou Community, Ronggui Subdistrict,  
Shunde District, Foshan City, Guangdong, China 528306.  
Tel. +86 757 2636 9861  
Fax. +86 757 2881 9700  
domestic@merryfair.com.cn

**Merryfair (Singapore) Pte Ltd**  
33 Ubi Avenue 3, #01-52/53 Vertex,  
Singapore 408868.  
Tel. +65 6284 9098  
Fax. +65 6284 9028  
enquiry@merryfair.com.sg

**Merryfair (Thailand) Co.,Ltd**  
Thai Samut Building  
Ground Floor, 163 Surawongse Road,  
Bangrak, Bangkok 10500 Thailand.  
Tel. +66 2266 3855  
Fax. +66 2266 3859  
sales@merryfair.co.th

[www.merryfair.com](http://www.merryfair.com)

