

MATA

MERRYFAIR®

Seating Products



Seating Excellence at Work

The ever popular Mata welcomes new additions to its family — Mata offsprings.



Comfort

For 10 years, Mata has proven its comfort, durability and design appeal, and now, children can enjoy the same qualities as well.

Low Maintenance

Designed following EN-1729 standards, these chairs serve child-care, pre-school and elementary school facilities perfectly.

Sustainability

Mata is designed as multi-purpose chair suitable for cafes, bistros, labs, waiting and SOHO.



Shell Structure

Single-piece shell of injection-moulded polypropylene in 7 standard colour options. Backrest is designed for flexible movement and with lumbar curvature.



Arm Structure

Mild steel framework, finished in silver-colour epoxy coating.

Mechanism

Hillie Box mechanism for lever operated seat height adjustment. Mechanism body made of die-cast aluminium finished in black epoxy, lever of painted steel, and handle moulded of polypropylene.

Base

Five-point base moulded in black polypropylene, with a diameter of 600mm. Five castor wheels moulded in black Nylon.

Stacking Chair

5 frames available



4 Leg
G05?* NA A00 H



4 Leg with arm
G05?* NA A21 H



Reverse Cantilever
G05?* NA A00 Z



4 Leg Bar Chair
G056* NA A00 HH



4 Leg Bar Chair with Arm
G056* NA A21 HH

7 Sizes
From Toddler to Adult

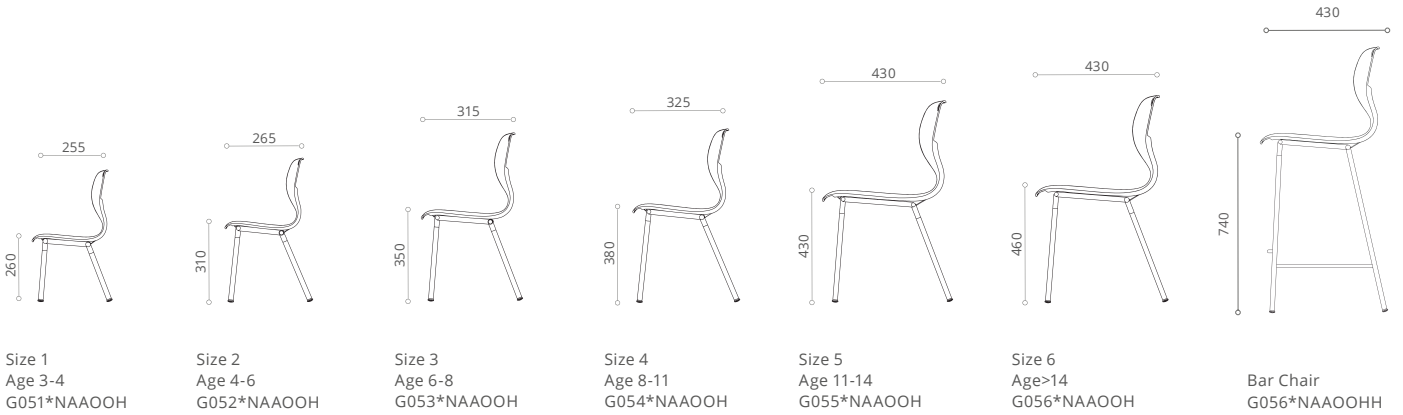

Swivel Chair
2 sizes available



Link Chair

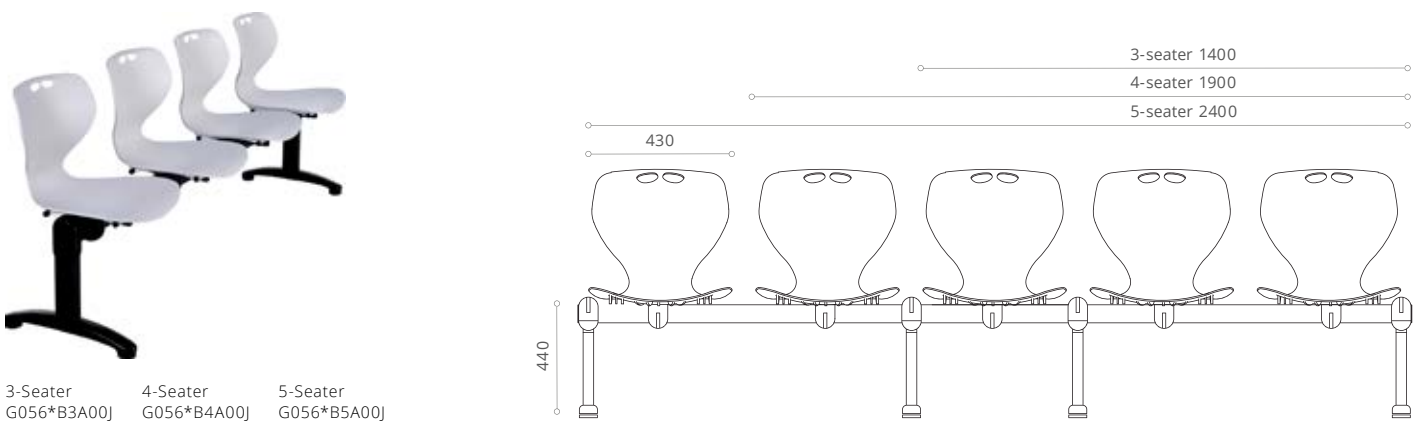

Features



Stackable chairs for general multi-purpose seating. 4 leg and reverse cantilever leg versions are stackable. Reverse cantilever allows chair to be placed on top of table for ease of floor cleaning.



Swivel chair for workstation seating. A height-adjustable swivel mechanism running on castors ensures excellent fit and mobility.



Linked for public seating. The beam supported system is available as 3,4 and 5 seaters.

Color Options

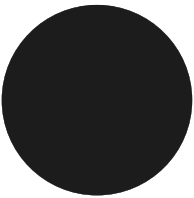

Black
(B)

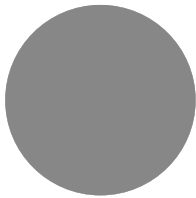

Grey
(G)

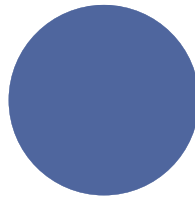

Blue
(U)

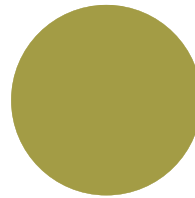

Olive
(L)

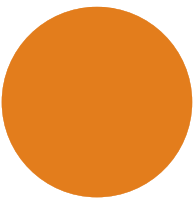

Mango
(M)

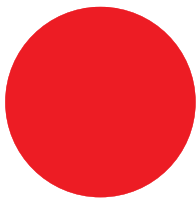

Red
(R)

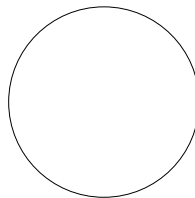

White
(P)

Padding Options



Padded Seat
for size 5 and 6 only

Size 5
G045* NAA__?

Size 6
G046* NAA__?

HEAD OFFICE & FACTORY

Merryfair Chair System Sdn Bhd
(Co. No. 86276-A)
No.2, Jalan Koporat 1/KU9,
Taman Perindustrian Meru,
42200 Klang, Selangor D.E., Malaysia.

International Sales & Marketing
Tel. +603 3393 2888
Fax. +603 3393 2000
enquiry@merryfair.com

Domestic Sales & Marketing
Tel. +603 3393 6868
Fax. +603 3393 6888
domestic@merryfair.com

SHOWROOM OFFICE

Merryfair Marketing Sdn Bhd
(Co. No. 665054-V)
No. 82-84, Jalan 2/23A,
Jalan Genting Kelang,
53300 Kuala Lumpur, Malaysia.
Tel. +603 4149 8899
Fax. +603 4143 0113

REGIONAL OFFICE & SHOWROOM

美力菲 (中国) 家具有限公司
广东省佛山市顺德区容桂华口顺德高新区(容桂)华天路21号
邮编: 528306
Merryfair (China) Co.,Ltd
No. 21, Huatian Road, Shunde High Tech Industrial Zone
(Ronggui), Huakou Community, Ronggui Subdistrict,
Shunde District, Foshan City, Guangdong, China 528306.
Tel. +86 757 2636 9861
Fax. +86 757 2881 9700
domestic@merryfair.com.cn

Merryfair (Singapore) Pte Ltd
33 Ubi Avenue 3, #01-52/53 Vertex,
Singapore 408868.
Tel. +65 6284 9098
Fax. +65 6284 9028
enquiry@merryfair.com.sg

Merryfair (Thailand) Co.,Ltd
Thai Samut Building
Ground Floor, 163 Surawongse Road,
Bangrak, Bangkok 10500 Thailand.
Tel. +66 2266 3855
Fax. +66 2266 3859
sales@merryfair.co.th

www.merryfair.com

