

# STADIUM

MERRYFAIR®

Seating Products

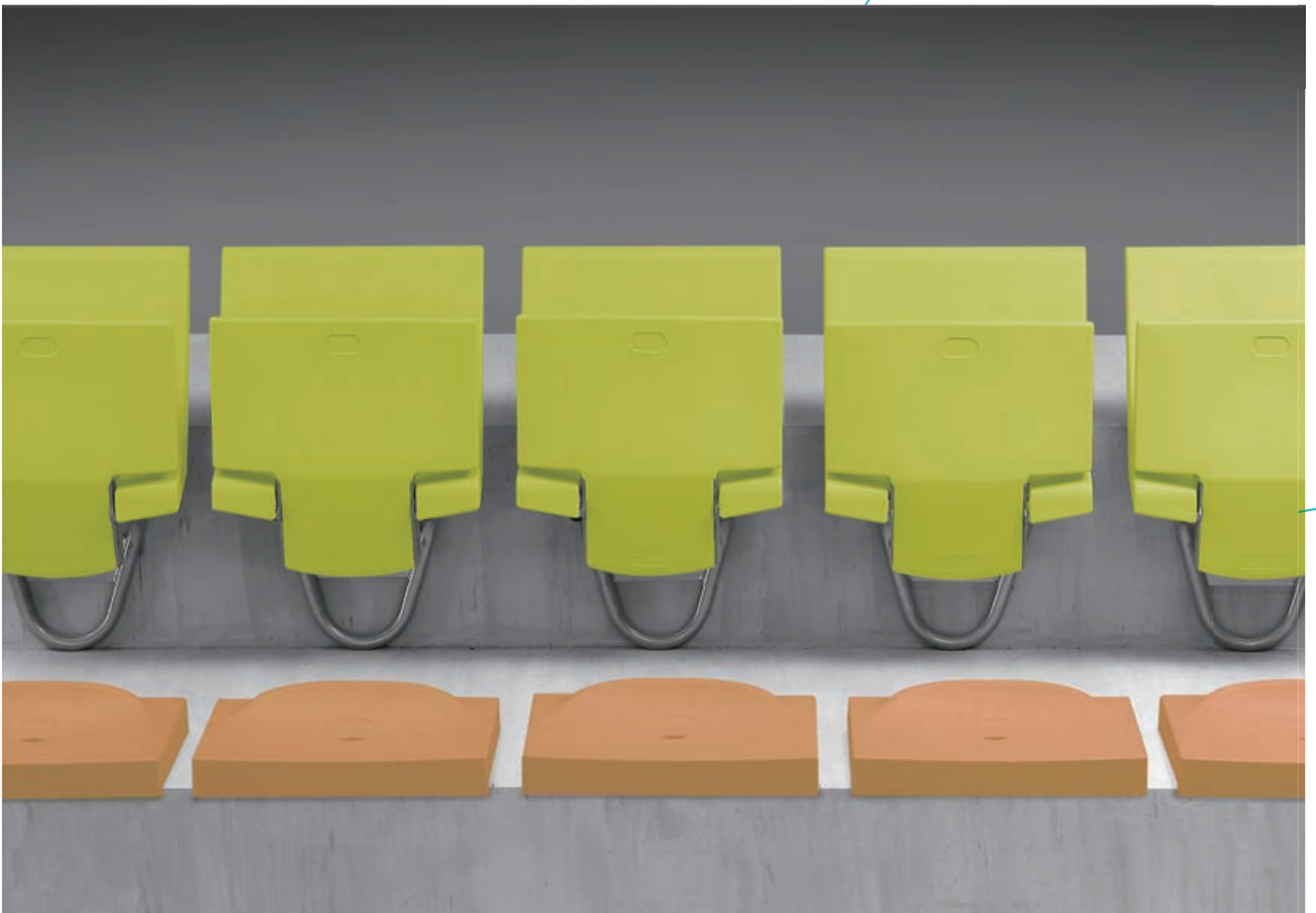

**Seating Excellence at Work**

Merryfair's outdoor stadium seating collection.  
Durable seating available in vibrant colours.  
Discover the Sporta, Ola, Oahu.

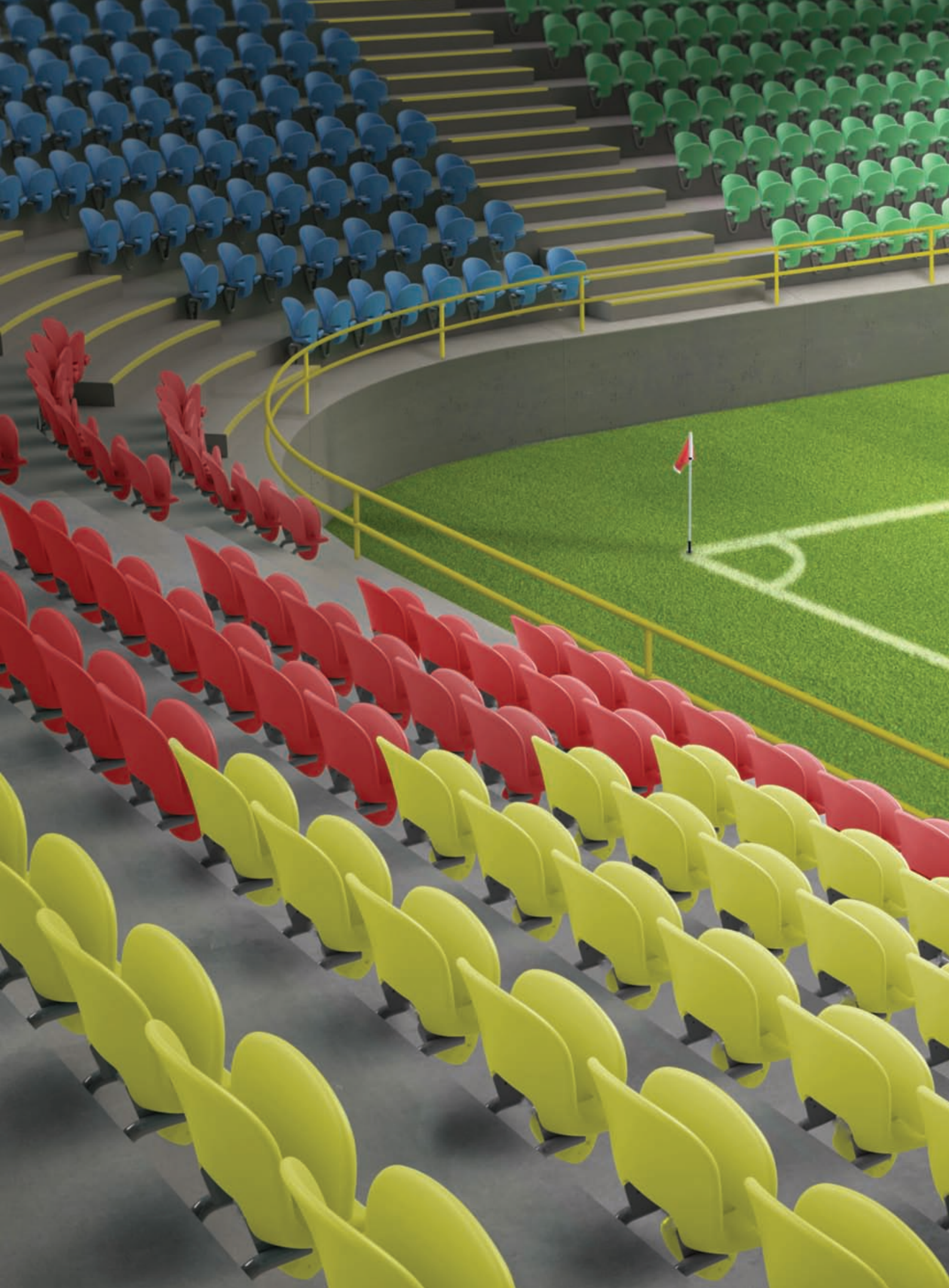



**Comfort**

The tip-up seat is ergonomically designed for total comfort, even when the fight takes you to the 12th round.

**Low Maintenance**

The back and seat are of blow-moulded thermoplastic, durable and strong enough to withstand abuse, be it the elements, or over-excited fans.

**Sustainability**

Sporta is suitable for both indoor and outdoor sports, multipurpose, and school facilities.

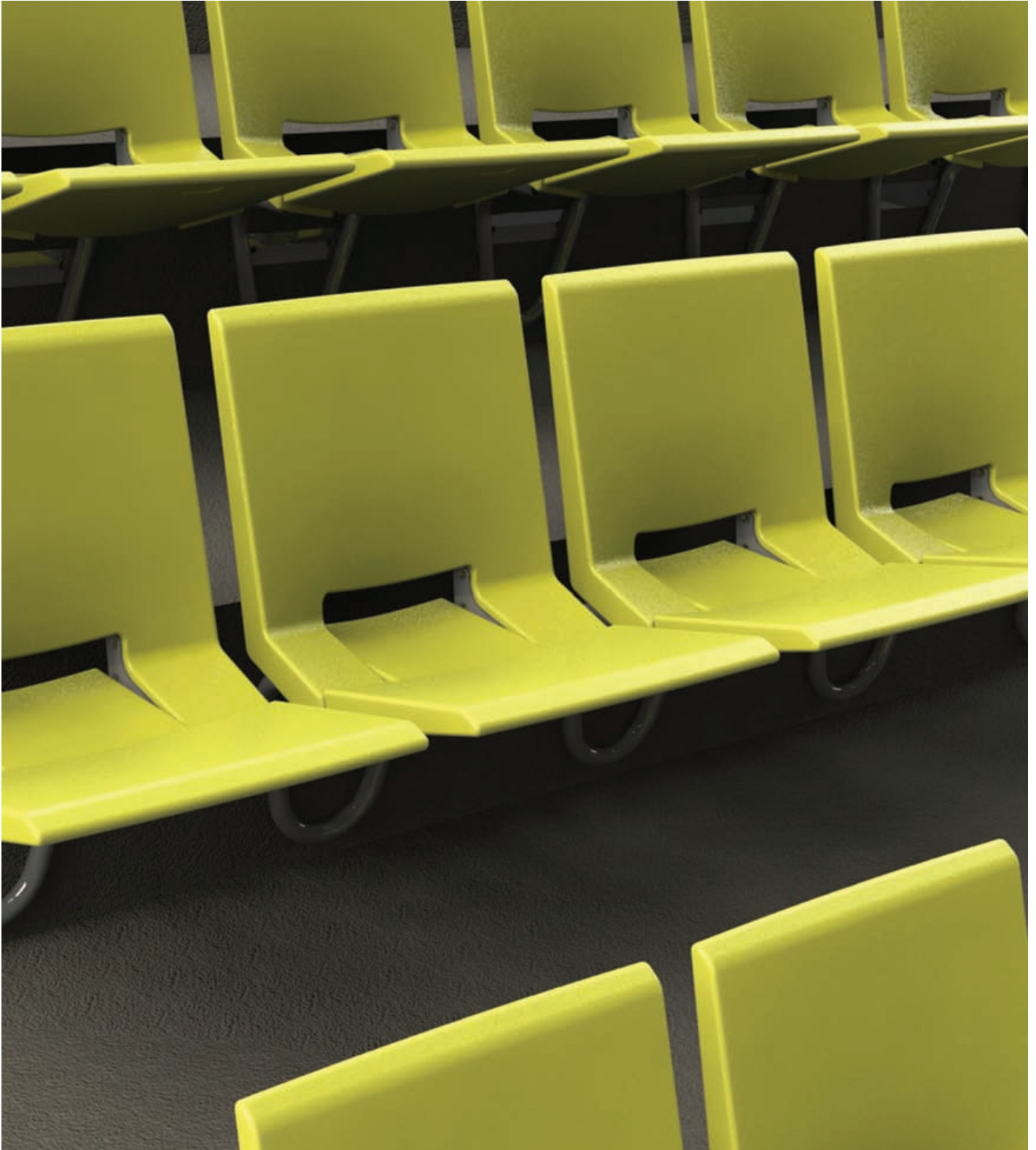

Sporta is our stadium seating series that has a more architectural shape for more geometrically styled arenas.

Seat numbering plate of aluminium sheet stamping.

Supporting structure made of steel, finished in epoxy powder coating (60-80 micron thickness). Mounting options: on to riser wall or floor.



Seat and back shells of blow moulded HDPE with additives for UV colour-fastness and fire resistance up to customer requirement.

Seat retraction using gravity (counter weight) and POM (polyacetal) bushings at joints ensure smooth trouble free operation.

### Comfort

Its organic shape provides both comfort and style to your next sporting event.

### Low Maintenance

The back and seat are of blow-moulded thermoplastic, versatile enough to withstand the elements and the fans.

### Sustainability

Ola is suitable for both indoor and outdoor sports, multipurpose, and school facilities.

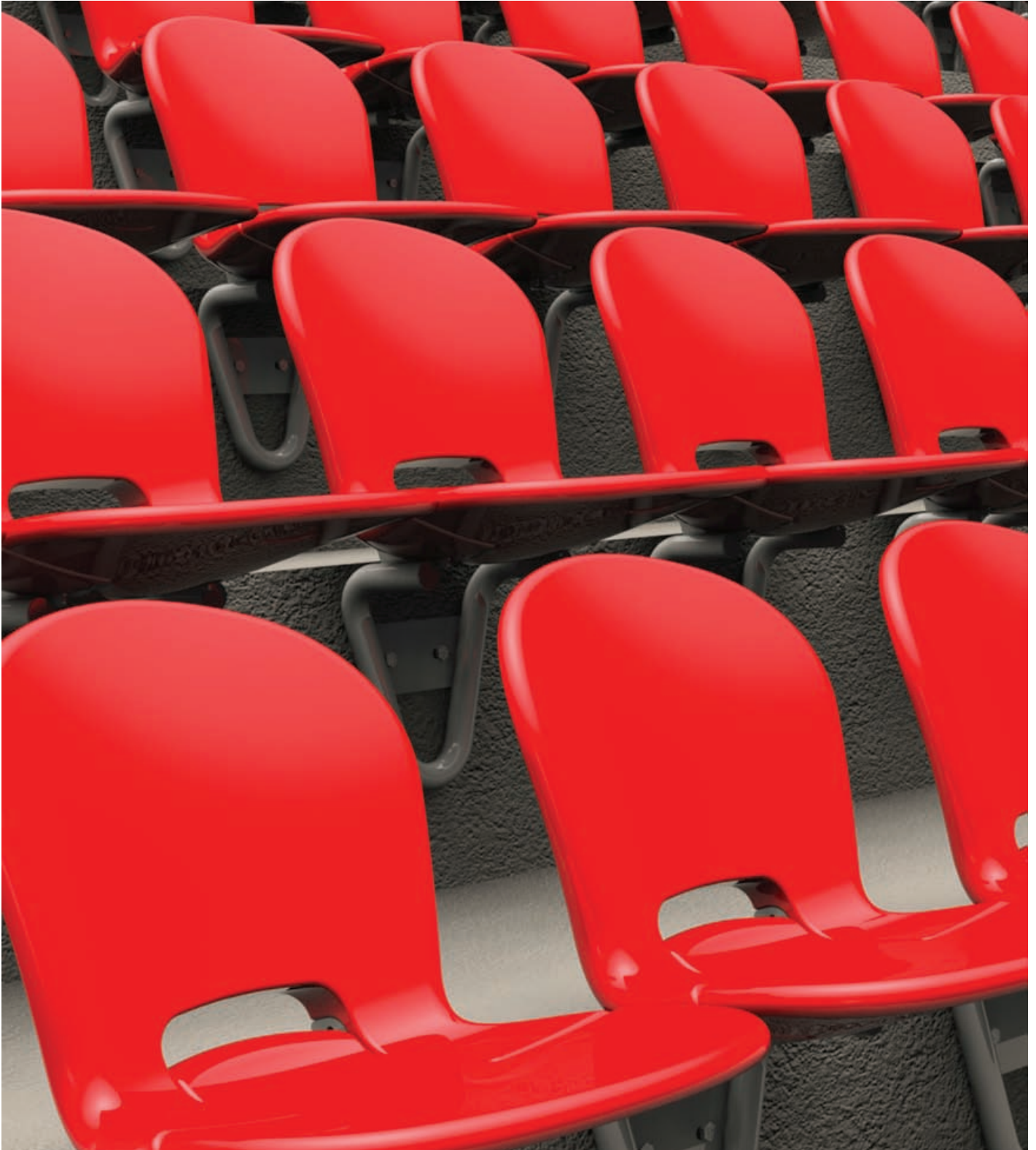

## Ola is the curvy one in our line of stadium seating.

Seat numbering plate of aluminium sheet stamping.

Supporting structure made of steel, finished in epoxy powder coating (60-80 micron thickness). Mounting options: on to riser wall or floor.



Seat and back shells of blow moulded HDPE with additives for UV colour-fastness and fire resistance up to customer requirement.

Seat retraction using gravity (counter weight) and POM (polyacetal) bushings at joints ensure smooth trouble free operation.



**Comfort**

The Oahu one piece seat is great choice for its modularity, ease of installation, and its uncompromising comfort.

**Low Maintenance**

Its compact dimensions and lack of moving parts make it easy to install in various seating arrangements.

**Sustainability**

Oahu is suitable for both indoor and outdoor sports, multipurpose, and school facilities.

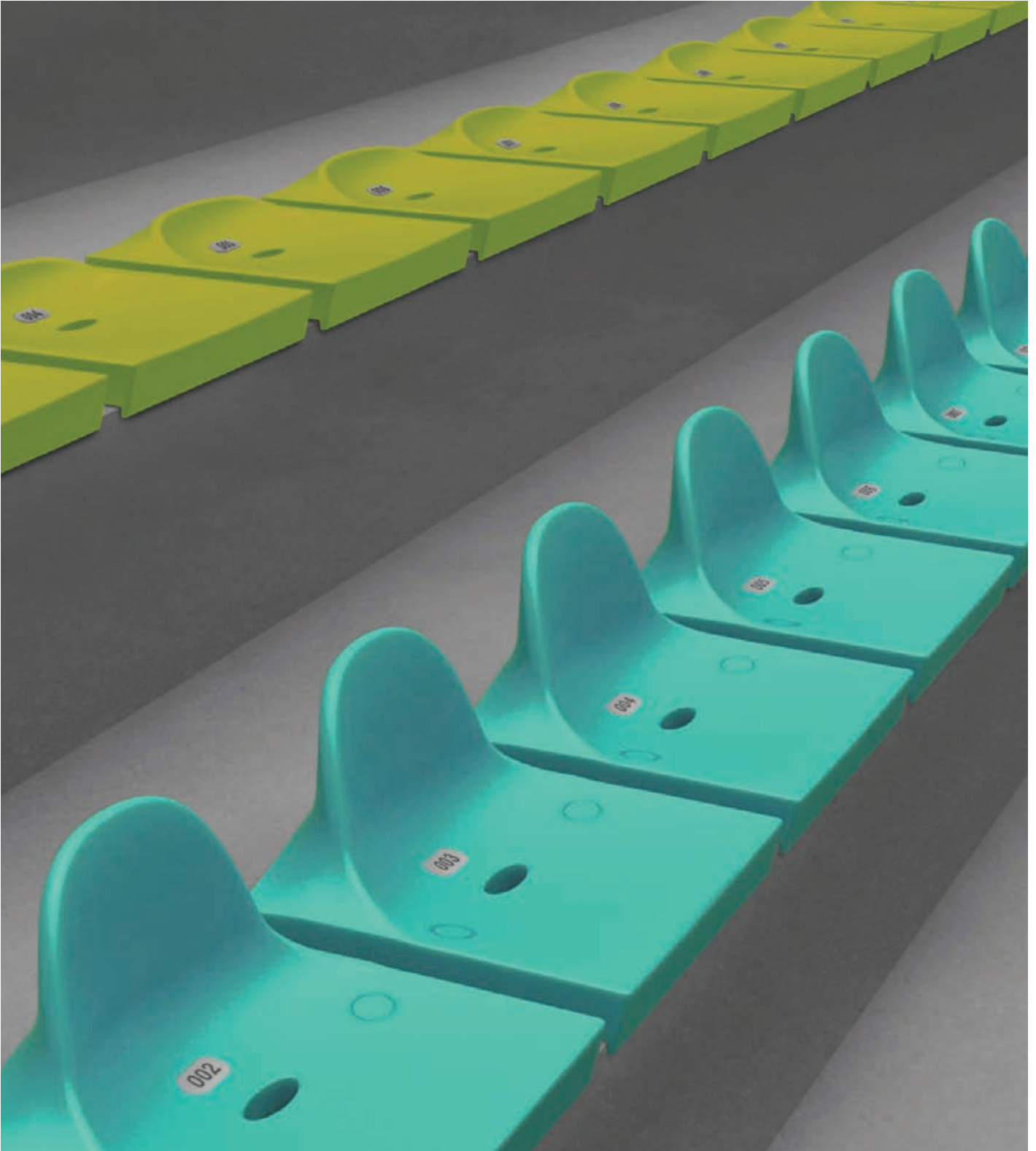



Oahu was inspired by the rippling motion of waves, where the back crests from high to low.

Seat shells of injection-moulded PP (polypropylene) with additives for UV colour-fastness and fire resistance up to customer requirement. Low back (1105) and backless (1101) versions are available.

Hole for rain-water drainage.

Flush front edge minimises hand grip area to prevent seat from being lifted up by vandals.

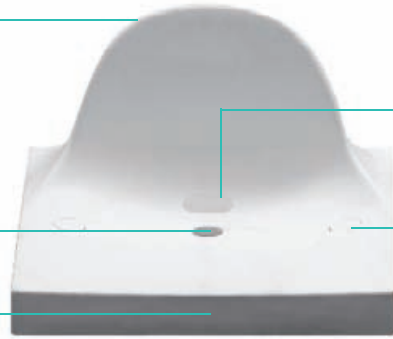

Seat numbering plate of aluminium sheet stamping.

Mounts directly on to step. Mounting holes are covered by flushing fitting caps that cannot be pried off by hand.

**Sporta - Wall Mounted**  
**1085FDA00AJ**

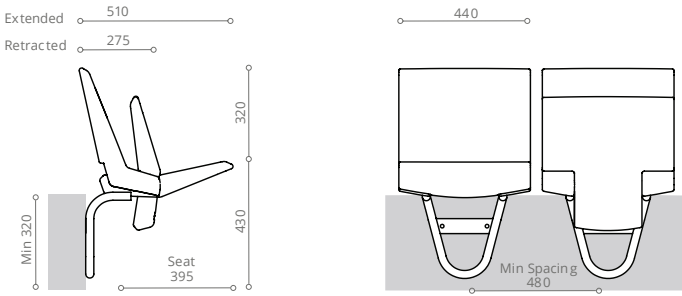

**Sporta - Floor Mounted**  
**1085FDA00AH**

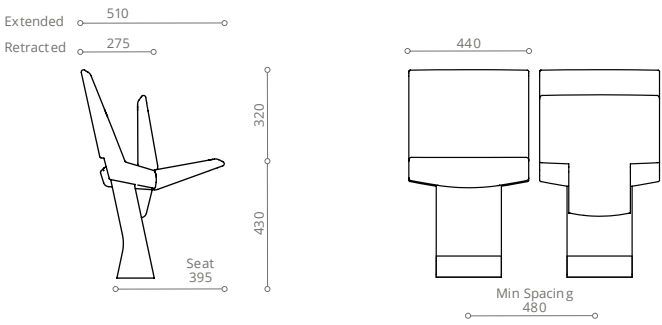

**Ola - Wall Mounted**  
**1095FDA00AJ**

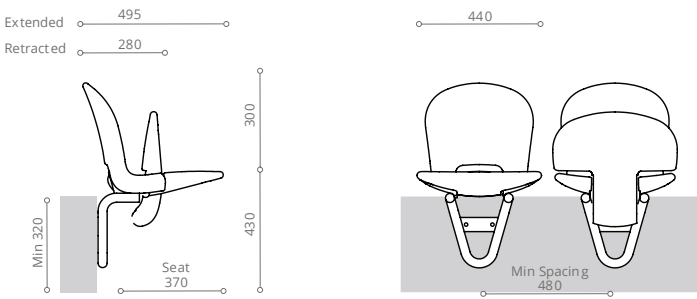

**Ola - Floor Mounted**  
**1095FDA00AH**

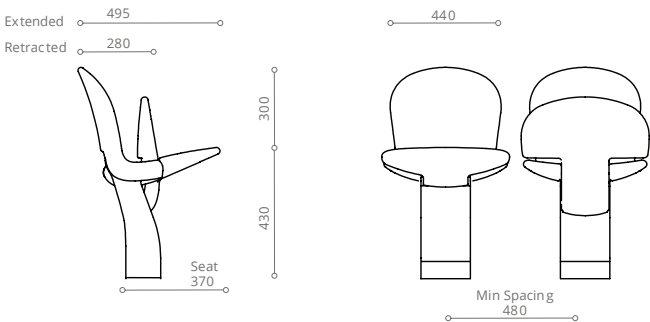

**Oahu - Backless**  
1101NAA00NA

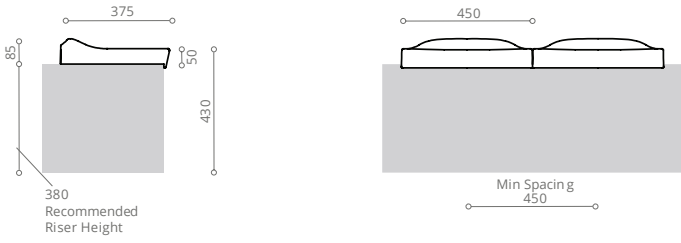

**Oahu - Low Back**  
1105NAA00NA

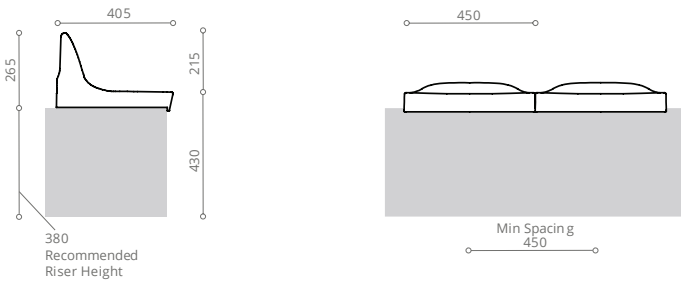

**Oahu - Backless Bench**  
1101B4A00J

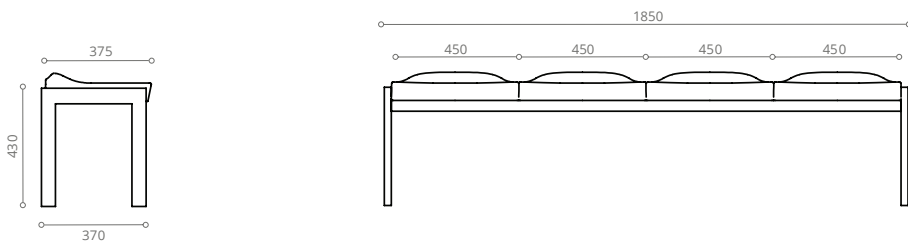

**Oahu - Low Back Bench**  
1105B4A00J

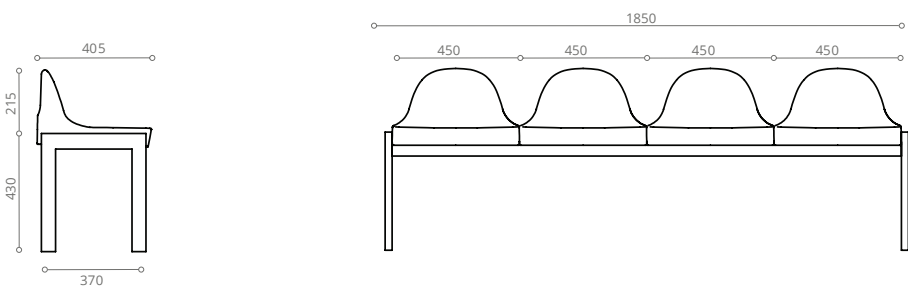

## HEAD OFFICE & FACTORY

**Merryfair Chair System Sdn Bhd**  
(Co. No. 86276-A)  
No.2, Jalan Koporat 1/KU9,  
Taman Perindustrian Meru,  
42200 Klang, Selangor D.E., Malaysia.

**International Sales & Marketing**  
Tel. +603 3393 2888  
Fax. +603 3393 2000  
enquiry@merryfair.com

**Domestic Sales & Marketing**  
Tel. +603 3393 6868  
Fax. +603 3393 6888  
domestic@merryfair.com

## SHOWROOM OFFICE

**Merryfair Marketing Sdn Bhd**  
(Co. No. 665054-V)  
No. 82-84, Jalan 2/23A,  
Jalan Genting Kelang,  
53300 Kuala Lumpur, Malaysia.  
Tel. +603 4149 8899  
Fax. +603 4143 0113

## REGIONAL OFFICE & SHOWROOM

**美力菲 (中国) 家具有限公司**  
广东省佛山市顺德区大良南国西路安利工业区  
**Merryfair (China) Co.,Ltd**  
Anli Industrial Area, Nan Guo Xi Lu,  
Daliang, Shunde Area, Foshan City,  
Guangdong Province, China 528305.  
Tel. +86 757 2636 9861  
Fax. +86 757 2881 9700  
domestic@merryfair.com.cn

**Merryfair (Singapore) Pte Ltd**  
33 Ubi Avenue 3, #01-52/53 Vertex,  
Singapore 408868.  
Tel. +65 6284 9098  
Fax. +65 6284 9028  
enquiry@merryfair.com.sg

**Merryfair (Thailand) Co.,Ltd**  
Thai Samut Building  
Ground Floor, 163 Surawongse Road,  
Bangrak, Bangkok 10500 Thailand.  
Tel. +66 2266 3855  
Fax. +66 2266 3859  
sales@merryfair.co.th

