

ROVER

MERRYFAIR®

Seating Products



The Modern Classroom

Rover is the tool that will cross boundaries of “immobile” classrooms, enabling educators to provide a modern and effective arena for learning. Rover is designed to be mobile and adaptable in limited spaces and dense classrooms. A room can be transformed from theatre setting to a U-shaped setting effortlessly by moving the chairs around. This allows for maximum utilisation of space as well as increasing interaction between student and teacher.



Model: 92_BC AW1 AP



Features



Back shell design breathes like mesh.

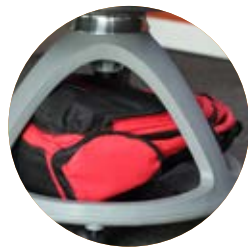

The base tray provides approximate 35 liters space for personal belongings.



Plastic seat shell comes in 3 colour options and require less maintenance.



Foldable A4 size writing tablet with Anti-Panic mechanism is tested to 50kg loads.

Model: 92_BD AW1 AR



Features



Back shell design breathes like mesh.



The base tray provides approximate 30 liters space for personal belongings. Pockets on both side for drinks bottles etc.



Plastic seat shell comes in 3 colour options and require less maintenance.



A3 size tablet, 360° swingable on its support arm. Slot for tablet or mobile devices.

Seat Shell

Injection-moulded polypropylene shell in choice of 3 colours (100% recyclable).

Optional Seat Upholstery

Upholstered over polyurethane cut foam (recyclable into carpet padding, wadding etc).

Tablet

Model: BD

A3 size tablet can swing 360° on its support arm for left or right handed arounded seat. Slot for tablet or mobile devices.

Base

AR Square Base

Moulded polypropylene base in standard grey colour equipped with 50mm dual-wheel castors.

Chair Shell

Injection-moulded polypropylene shell in white or grey (100% recyclable).

Tablet

Model: BC

Writing tablet uses an anti-panic mechanism and is tested to 50kg loads. Its generous size accommodates an open A4 book or 15" notebook computer. Recessions for a pen and cup.

Base

AP Tri-pod Base

600mm diameter storage base of grey moulded polypropylene equipped with 50mm dual-wheel castors.



PP Seat
923P BC AW1 AP



Padded Seat
924P BC AW1 AP

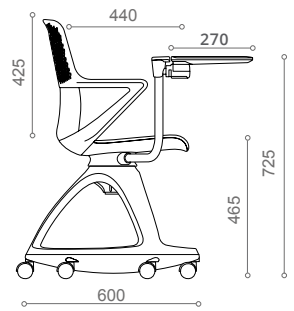
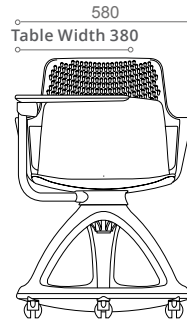

923P BD AW1 AR



924P BD AW1 AR

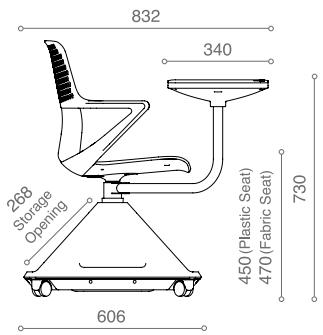
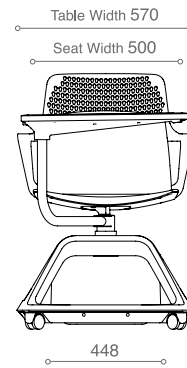

923G HB A71 N3



924G HB A71 N3

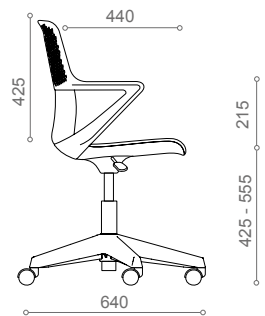
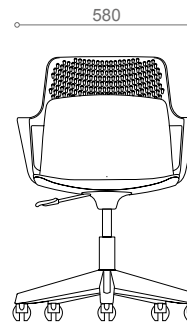

Rover: Option
PP Seat Colour

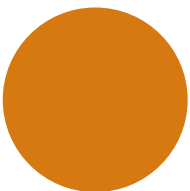

Mango
(M)

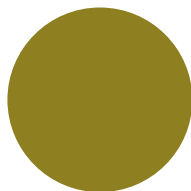

Olive
(L)

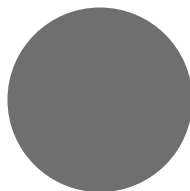

Charcoal
(C)

HEAD OFFICE & FACTORY

www.merryfair.com

Merryfair Chair System Sdn Bhd

(Co. No. 86276-A)
No.2, Jalan Koporat 1/KU9,
Taman Perindustrian Meru,
42200 Klang, Selangor D.E., Malaysia.

International Sales & Marketing

Tel. +603 3393 2888
Fax. +603 3393 2000
enquiry@merryfair.com

Domestic Sales & Marketing

Tel. +603 3393 6868
Fax. +603 3393 6888
domestic@merryfair.com

SHOWROOM OFFICE

Merryfair Marketing Sdn Bhd

(Co. No. 665054-V)
No. 82-84, Jalan 2/23A,
Jalan Genting Kelang,
53300 Kuala Lumpur, Malaysia.
Tel. +603 4149 8899
Fax. +603 4143 0113

REGIONAL OFFICE & SHOWROOM

美力菲 (中国) 家具有限公司

广东省佛山市顺德区容桂华口顺德高新区(容桂)华天路21号
邮编: 528306

Merryfair (China) Co.,Ltd

No. 21, Huatian Road, Shunde High Tech Industrial Zone
(Ronggui), Huakou Community, Ronggui Subdistrict,
Shunde District, Foshan City, Guangdong, China. 528306
Tel. +86 757 2636 9861
Fax. +86 757 2881 9700
domestic@merryfair.com.cn

Merryfair (Singapore) Pte Ltd

33 Ubi Avenue 3, #01-52/53 Vertex,
Singapore 408868.
Tel. +65 6284 9098
Fax. +65 6284 9028
enquiry@merryfair.com.sg

Merryfair (Thailand) Co.,Ltd

Thai Samut Building
Ground Floor, 163 Surawongse Road,
Bangrak, Bangkok 10500 Thailand.
Tel. +66 2266 3855
Fax. +66 2266 3859
sales@merryfair.co.th

